

PRÍSLUŠENSTVO PRE MPC MPC-RA / MPC-RP / MPC-BO / MPC-FL / MPC-SU

POPIS

Toto príslušenstvo sa používa pre priemyselné axiálne ventilátory VORTICEL MPC s montážou do potrubia. **MPC RA** je nástavec pre pružné pripojenie potrubia, ktorý redukuje vyosenie a vibrácie potrubia. **MPC RP** je ochranná mriežka, ktorá sa používa pri montáži ventilátora na koniec potrubia. **MPC BO** je sací nástavec, pre optimálne nasávanie resp. redukciu hluku. **MPC FL** je prírubka na redukciu pripojenia na potrubie. **MPC SU** sú podstavce pre ukotvenie ventilátora.

ROZMERY A INŠTALÁCIA

MPC-RA

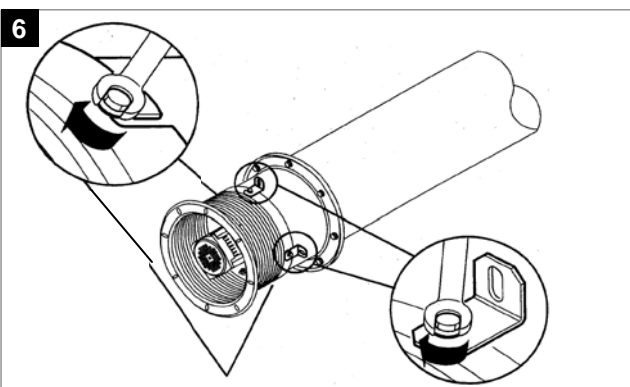
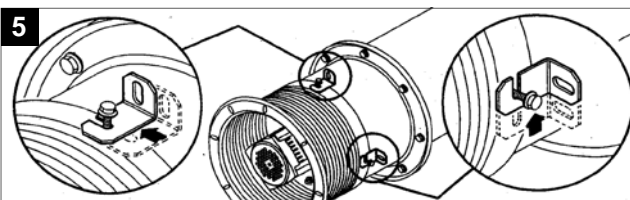
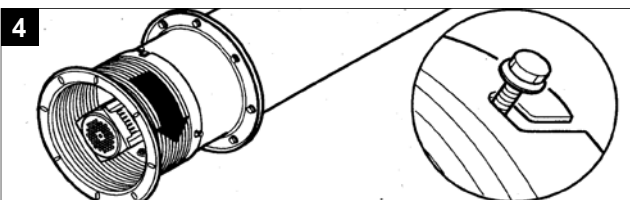
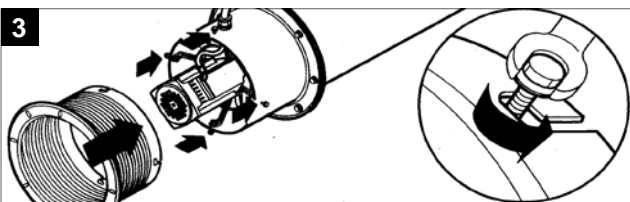
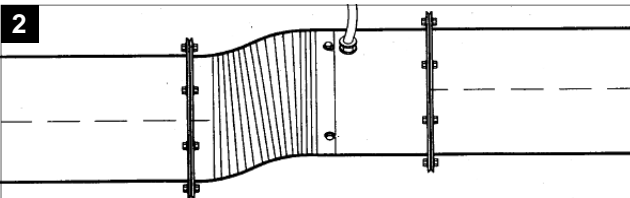
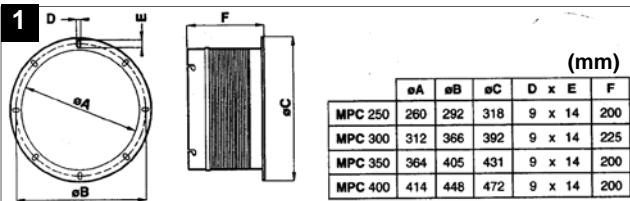

MPC-RP

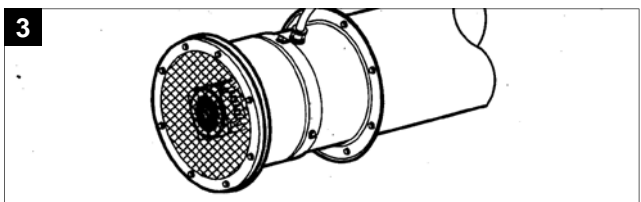
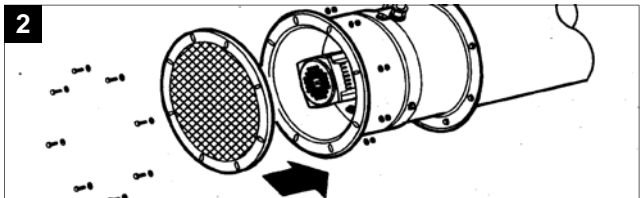
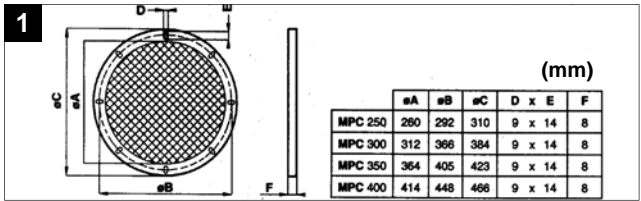

MPC-BO

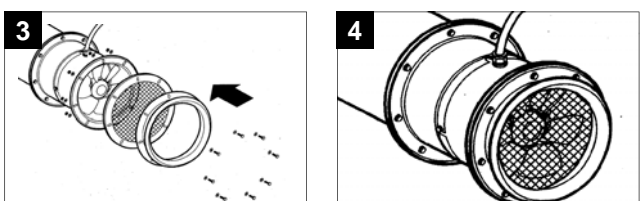
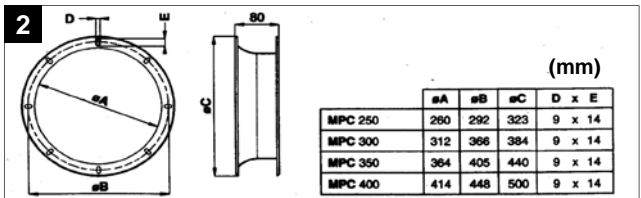
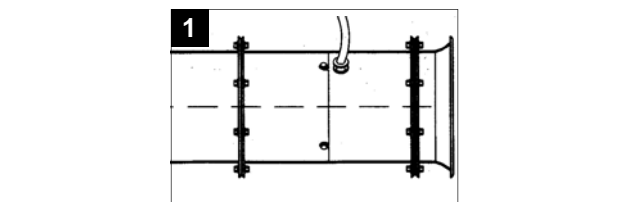

MPC-FL

1

	eA	eB	eC	D x E
MPC 250	260	292	318	9 x 14
MPC 300	312	366	392	9 x 14
MPC 350	364	405	431	9 x 14
MPC 400	414	448	472	9 x 14

(mm)

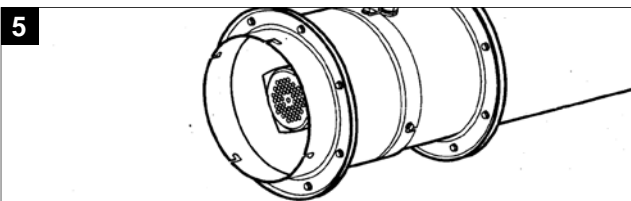
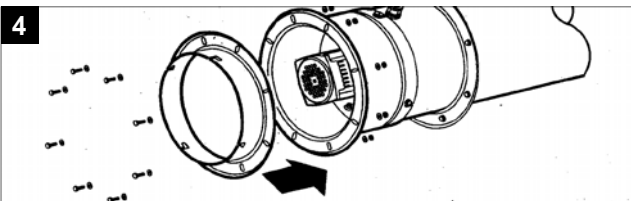
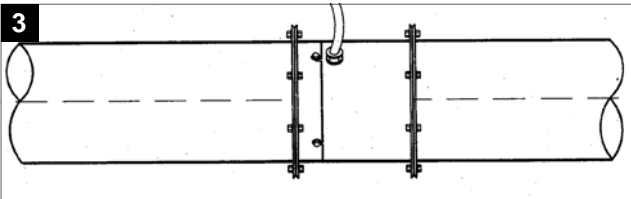
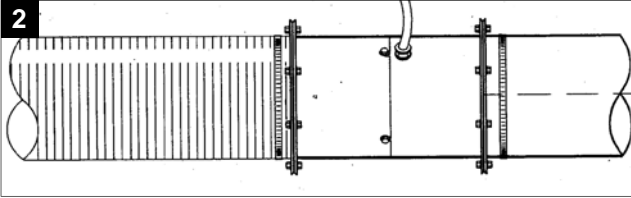

MPC-SU

1

	A	eB	C	D
MPC 250	240	292	25	120
MPC 300	295	366	25	120
MPC 350	320	405	25	130
MPC 400	360	448	25	140

(mm)

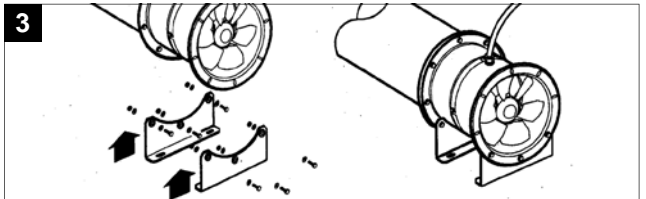
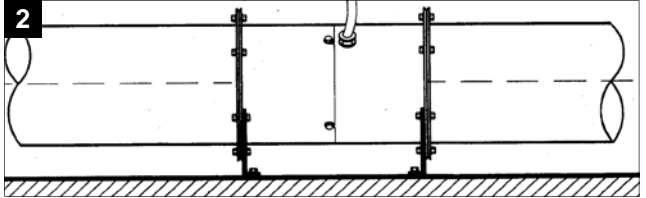

Zmena obrázkov a údajov je vyhradená.